

NOTES:

- Gate shown with left hand outswing
- 3" 12ga Galvanized Jamb (standard)
- 1-3/4" 14ga Galvanized Gate (standard)
- Rockwood Pull Handle
- Von Duprin 99 Series Exit Device with Quiet Electric Latch Retraction
- Torxun Autoped Model 10 Operator
- Terminal Box with connections to Operator (see installation instructions for wiring layout)
- Heavy Duty McKinney Hinge (x3) (standard)
- 1" Picket with X-Span Infill (other infill options available)

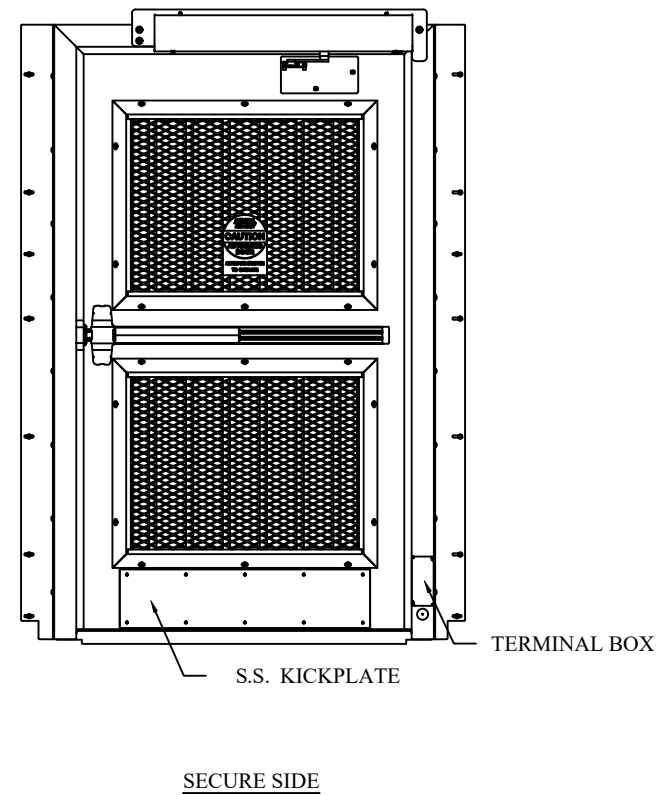

GATE SWING OPTIONS:

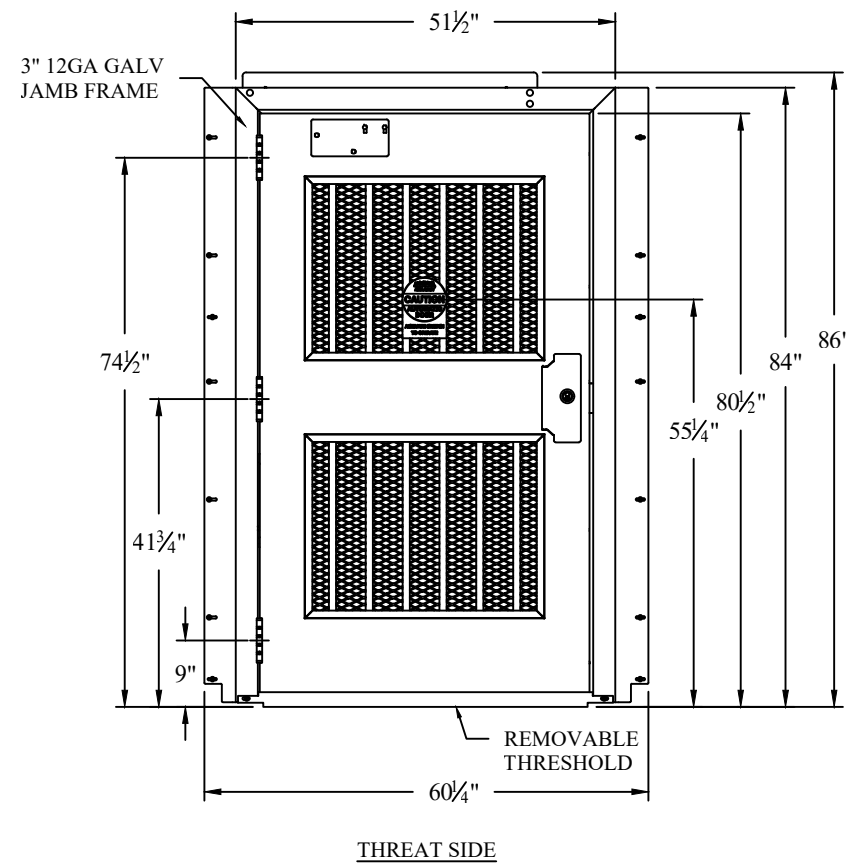
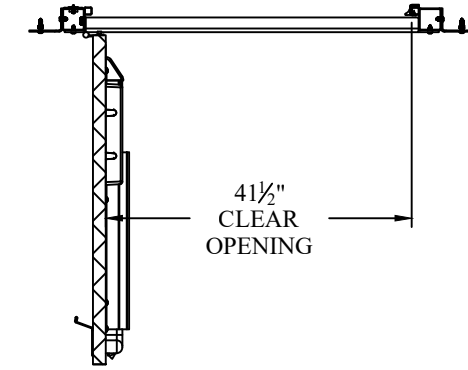
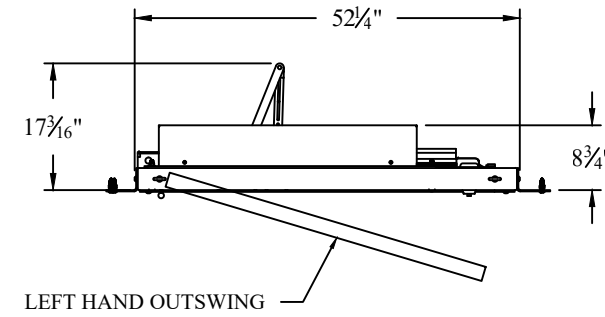
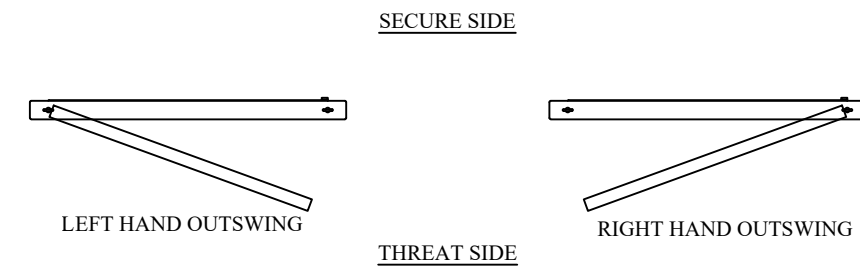

MOUNTING OPTIONS:

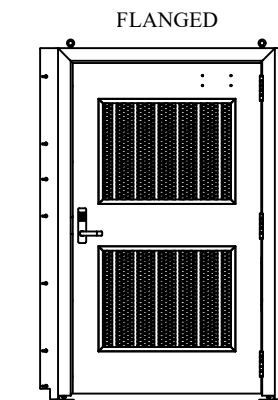

**HARDWARE OPTIONS:**

SET 3EL-AG  
 DETEX V40 EXIT DEVICE W/REQUEST TO EXIT SWITCH  
 ROCKWOOD VRT16 PULL HANDLE  
 TORXUN AUTOPED MODEL 10 OPERATOR  
 ELECTRIC LATCH RETRACTION

SET 4EL-AG  
 VON DUPRIN 99 SERIES EXIT DEVICE  
 ROCKWOOD VER16 PULL HANDLE  
 TORXUN AUTOPED MODEL 10 OPERATOR  
 QUIET ELECTRIC LATCH RETRACTION

SET 4CEL-AG  
 CBC VON DUPRIN 99 SERIES EXIT DEVICE  
 ROCKWOOD VER16 PULL HANDLE  
 TORXUN AUTOPED MODEL 10 OPERATOR  
 QUIET ELECTRIC LATCH RETRACTION

DETEX A40 (3AMP REQUEST TO EXIT SWITCH)

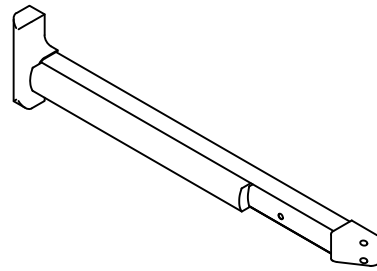

VON DUPRIN 99 SERIES DEVICE W.QUIET ELECTRIC LATCH RETRACTION

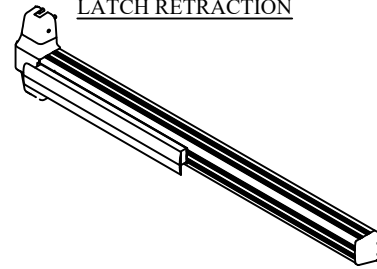

ROCKWOOD PULL HANDLE

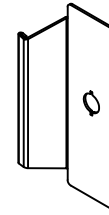

TORXUN AUTOPED MODEL 10 OPERATOR

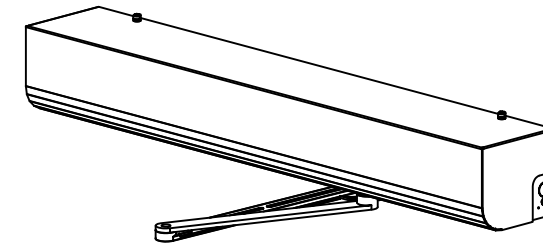

INFILL OPTIONS:

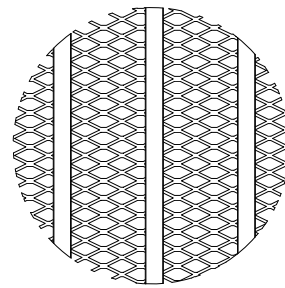

1" PICKET W/ $\frac{3}{4}$ " #9 FLAT EXPANDED METAL

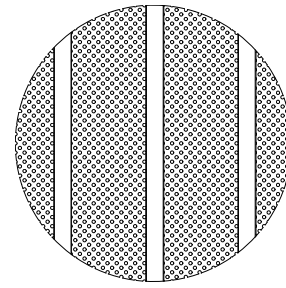

1" PICKET W/ $\frac{3}{16}$ " RND X  $\frac{1}{2}$ " 18GA PERF

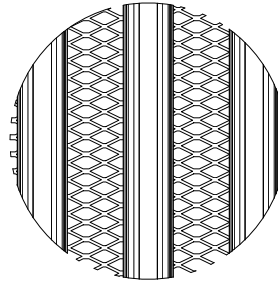

PALE W/ $\frac{3}{4}$ " #9 FLAT EXPANDED METAL

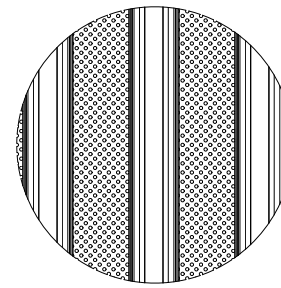

PALE W/ $\frac{3}{16}$ " RND X  $\frac{1}{2}$ " 18GA PERF

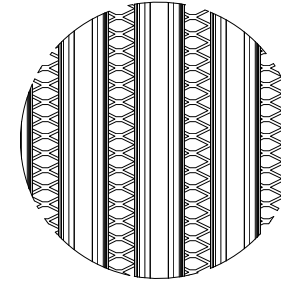

ANTI-CLIMB PALE W/ $\frac{3}{4}$ " #9 FLAT EXPANDED METAL

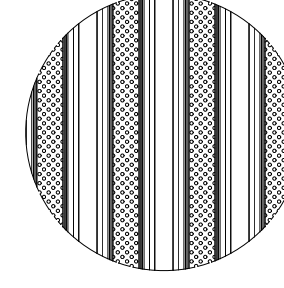

ANTI-CLIMB PALE W/ $\frac{3}{16}$ " RND X  $\frac{1}{2}$ " 18GA PERF

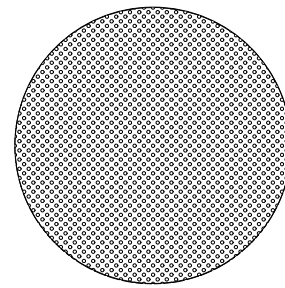

$\frac{3}{16}$ " RND X  $\frac{1}{2}$ " 18GA PERF

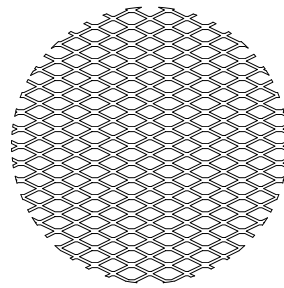

X-SPAN® .75" X #9F

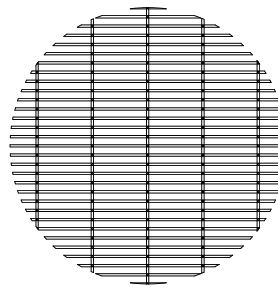

WIREWORKS ANTI-CLIMB® 3" X .5" X 10.5GA

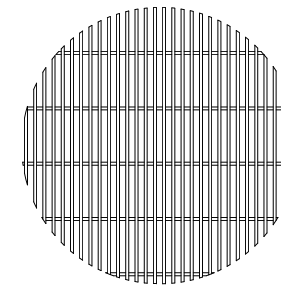

WIREWORKS® .5" X 3" X 8GA & 6GA

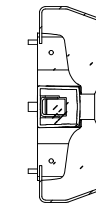

EXIT DEVICE GUARD  
 P/N: PHEG42

